

NICU PRODUCT CATALOG



Distributed By:

IMA

Independent Medical Associates

888.548.4462

 **Acacia**
Neonatal

Your Heart is in Neonatology. And So is Ours.

Acacia Neonatal is focused on designing and producing the best neonatal products to reduce infection, provide the safest enteral feeding and increase medication safety. These three key challenges face every Neonatal Intensive Care Unit (NICU) and require a dedicated and forward thinking partnership to solve.

Acacia's strong commitment to the NICU dates back to 1990, when it first designed and manufactured one of the first microbore tubing sets for low volume medication delivery.

That early commitment to advancing healthcare in the NICU has grown into the driving force behind the company today, as we work to help save these most vulnerable patients.

With our partner hospitals across the country, Acacia continues to research, develop and produce innovative products for some of the most dedicated medical professionals, the NICU staff. Together we continue to make progress in the fight to help save babies' lives.

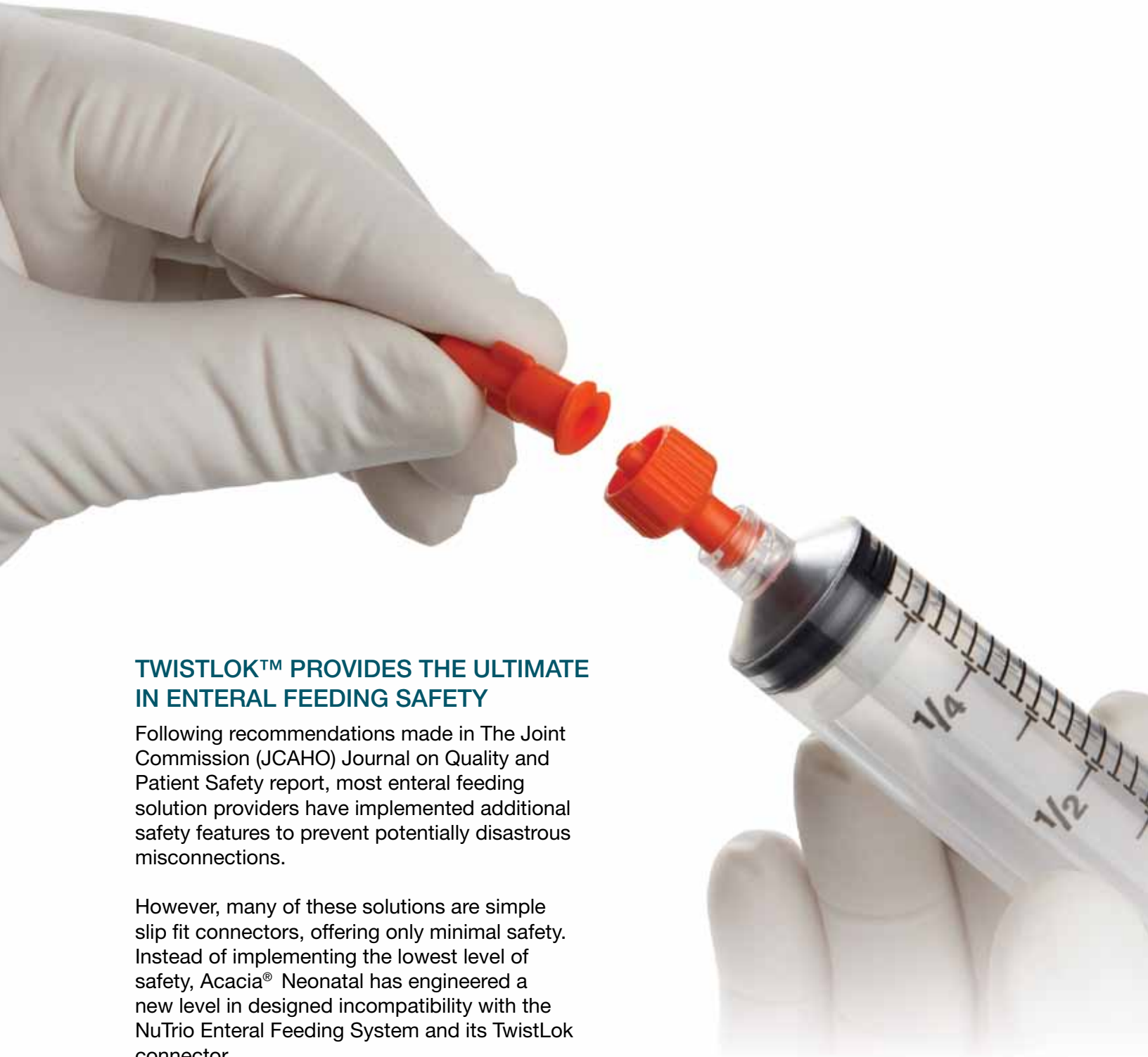

Table of Contents

NuTrio Enteral Feeding System	4 - 15
NuTrio: TwistLok™ Syringes.....	7
NuTrio: TwistLok™ Extension Sets	8
NuTrio: TwistLok™ PVC Feeding Tubes	9
NuTrio: TwistLok™ Polyurethane Feeding Tubes	10
NuTrio: TwistLok™ Silicone Feeding Tubes.....	10
NuTrio: GraviFeed™	11 - 13
NuTrio: Intopo™ Syringes	14
NuTrio: Intopo™ Extension Sets.....	15
ClosedCare™ I.V. Systems.....	16 - 19
MedSafe and Multi-Access Sets.....	20 - 28
NICU Speciality I.V. Sets	29 - 31

ELIMINATE
MISCONNECTIONS

NUTRIO ENTERAL FEEDING SYSTEM™



TWISTLOK™ PROVIDES THE ULTIMATE IN ENTERAL FEEDING SAFETY

Following recommendations made in The Joint Commission (JCAHO) Journal on Quality and Patient Safety report, most enteral feeding solution providers have implemented additional safety features to prevent potentially disastrous misconnections.

However, many of these solutions are simple slip fit connectors, offering only minimal safety. Instead of implementing the lowest level of safety, Acacia® Neonatal has engineered a new level in designed incompatibility with the NuTrio Enteral Feeding System and its TwistLok connector.

PRODUCT FEATURES & BENEFITS:

TwistLok: A New Level in Designed Incompatibility

- The NuTrio Enteral Feeding System provides secure locking connections to eliminate misconnections and disconnections.
- Introduces an additional safety feature requiring the user to consciously twist the hubs together in order for a connection to be made.
- Unlike slip fit connections that accidentally come apart and waste precious breastmilk, the TwistLok hubs stay connected even when wet or under tension.
- TwistLok threads are designed to be exposed for easy cleaning without changing standard hospital procedure.
- Flexible, open system allows connectivity with other oral systems while remaining incompatible with I.V. Luers.
- Follows all the safety standards as outlined by the JCAHO Sentinel Alert on enteral feeding.
- Non-DEHP, Latex Free.



SYRINGES



Safety – The NuTrio Enteral Safety System is color coded orange for easy identification.



Fit – Unique TwistLok design will NOT stretch out slip fit feeding tubes while remaining incompatible with I.V. luers.



Transport – The TwistLok cap offers the most secure fit for transportation between feeding preparation and bedside.

EXTENSION SETS



Medication Port – Optional Y-port for easy medication delivery.



TwistLok Connection – Extension sets feature the same secure TwistLok connections as the system's feeding tubes and syringes.



Flexibility – The TwistLok connection is compatible with most enteral feeding systems, avoiding costly supply chain interruptions.

FEEDING TUBES

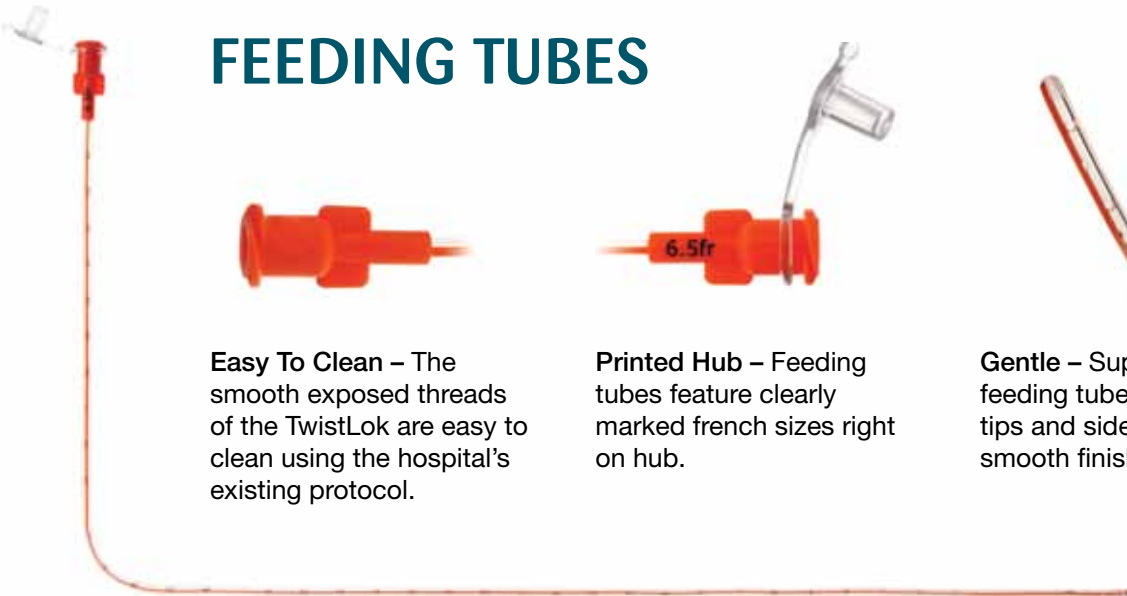

Easy To Clean – The smooth exposed threads of the TwistLok are easy to clean using the hospital's existing protocol.



Printed Hub – Feeding tubes feature clearly marked french sizes right on hub.



Gentle – Super soft silicone feeding tubes with open tips and side holes features smooth finished edges.

NuTrio: TwistLok™ Enteral Syringes

TL-INT-03 NuTrio TwistLok 3ml syringe

100
BOX

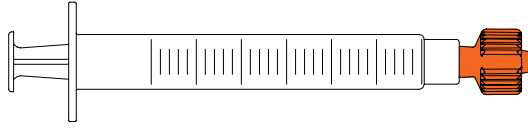

TL-INT-05 NuTrio TwistLok 5ml syringe

100
BOX

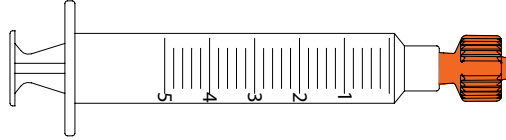

TL-INT-10 NuTrio TwistLok 10ml syringe

100
BOX

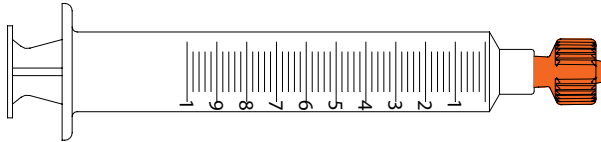

TL-INT-20 NuTrio TwistLok 20ml syringe

100
BOX

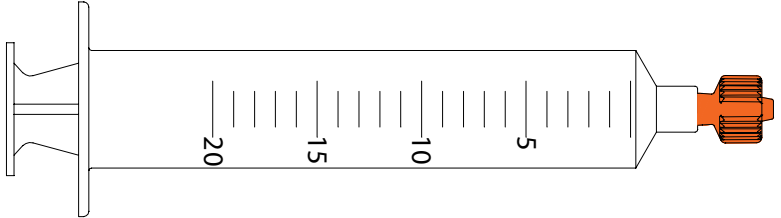

TL-INT-30 NuTrio TwistLok 30ml syringe

50
BOX

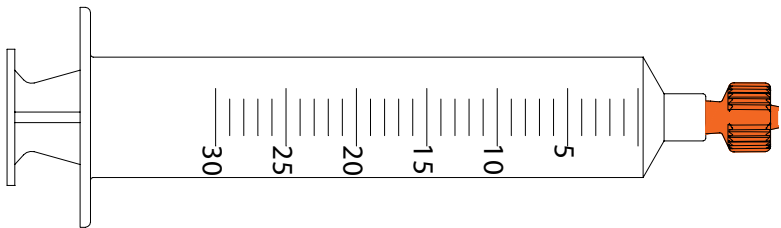

TL-INT-60 NuTrio TwistLok 60ml syringe

50
BOX

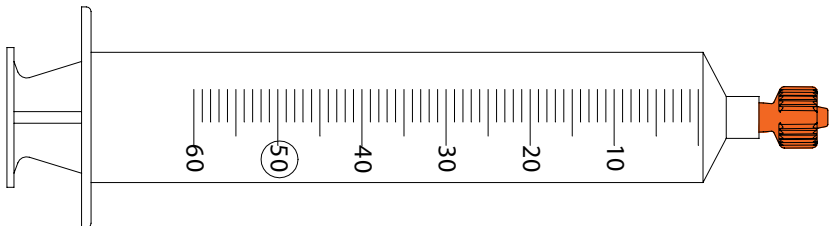

TL-CAP NuTrio TwistLok Non-Vented Cap

50
BOX

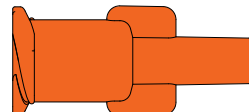

NuTrio: TwistLok™ Extension Sets and Accessories

TL-001 NuTrio TwistLok Accessory, Enteral Straw (For Milk Preparation)
Orange-Striped Standard Bore Tubing
TwistLok Female Adapter

PRIMING VOLUME:	0.40ml	100 BOX
LENGTH:	5.0"	



TL-002 NuTrio TwistLok Enteral Extension Set (G-Tube)
Orange-Striped Standard Bore Tubing
Universal Enteral Connector
Pinch Clamp (White)
TwistLok Female Adapter with Non-Vented Plug

PRIMING VOLUME:	1.20ml	50 BOX
LENGTH:	12.0"	

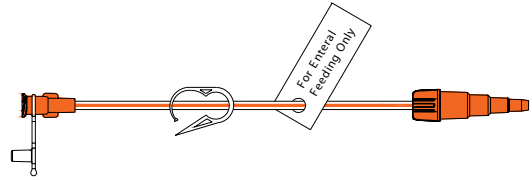

TL-060-18 NuTrio TwistLok Enteral Extension Set
Orange-Striped Low-Volume Minibore Tubing
TwistLok Male Adapter
Non-Removable Slide Clamp (White)
TwistLok Female Adapter

PRIMING VOLUME:	1.3ml	100 BOX
LENGTH:	60.0"	

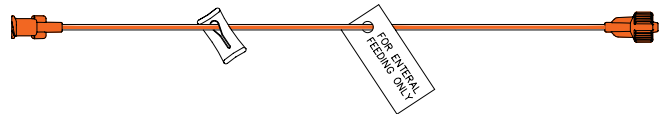

TL-060-182 NuTrio TwistLok Enteral Extension Set
Orange-Striped Minibore Tubing
TwistLok Male Adapter
Non-Removable Slide Clamp (White)
TwistLok Female Adapter

PRIMING VOLUME:	2.0ml	100 BOX
LENGTH:	60.0"	

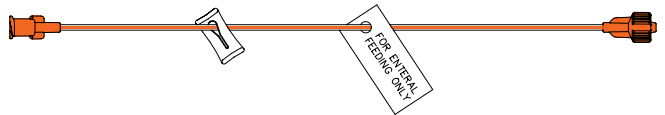

TL-060-19 NuTrio TwistLok Enteral Extension Set
Medication Port
Orange-Striped Low-Volume Minibore Tubing
TwistLok Male Adapter
Two Non-Removable Slide Clamps (White)
Two TwistLok Female Adapters
Non-Vented Plug

PRIMING VOLUME:	1.7ml	100 BOX
LENGTH:	60.0"	

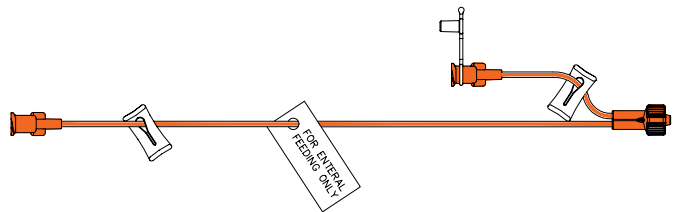

TL-060-192 NuTrio TwistLok Enteral Extension Set
Medication Port
Orange-Striped Minibore Tubing
TwistLok Male Adapter
Two Non-Removable Slide Clamps (White)
Two TwistLok Female Adapters
Non-Vented Plug

PRIMING VOLUME:	2.0ml	100 BOX
LENGTH:	60.0"	

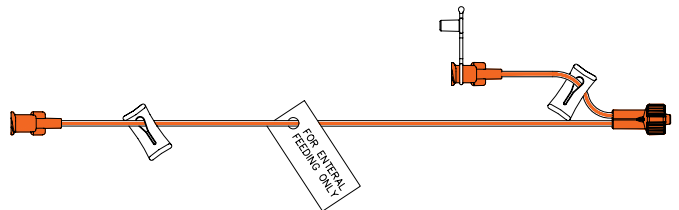

NuTrio: TwistLok™ PVC Feeding Tubes (For Use Up To 3 Days)



NuTrio TwistLok PVC Feeding Tube (For Use Up To 3 Days)

Orange-Striped Feeding Tube

Side Holes

TwistLok Female Adapter with Non-Vented Plug

ENPV-16-50	5 French		
	PRIMING VOLUME:	0.30ml	50 BOX
	LENGTH:	16.0"	

ENPV-36-50	5 French		
	PRIMING VOLUME:	0.90ml	50 BOX
	LENGTH:	36.0"	

ENPV-16-65	6.5 French		
	PRIMING VOLUME:	0.60ml	50 BOX
	LENGTH:	16.0"	

ENPV-36-65	6.5 French		
	PRIMING VOLUME:	1.20ml	50 BOX
	LENGTH:	36.0"	

ENPV-16-80	8 French		
	PRIMING VOLUME:	1.0ml	50 BOX
	LENGTH:	16.0	

ENPV-42-80	8 French		
	PRIMING VOLUME:	2.40ml	50 BOX
	LENGTH:	42.0"	

NuTrio: TwistLok™ Polyurethane and Silicone Feeding Tubes (For Use Up To 30 Days)



NuTrio TwistLok Polyurethane Feeding Tubes
(For Use Up To 30 Days)

Blue-Striped Feeding Tube

Side Holes

TwistLok Female Adapter with Non-Vented Plug

ENPU-20-50	5 French	PRIMING VOLUME: 0.40ml LENGTH: 20.0"	10 BOX
ENPU-36-50	5 French	PRIMING VOLUME: 0.80ml LENGTH: 36.0"	10 BOX
ENPU-20-65	6.5 French	PRIMING VOLUME: 0.80ml LENGTH: 20.0"	10 BOX
ENPU-36-65	6.5 French	PRIMING VOLUME: 1.20ml LENGTH: 36.0"	10 BOX
ENPU-20-80	8 French	PRIMING VOLUME: 1.20ml LENGTH: 20.0"	10 BOX
ENPU-42-80	8 French	PRIMING VOLUME: 2.40ml LENGTH: 42.0"	10 BOX
ENPU-42-100	10 French	PRIMING VOLUME: 4.00ml LENGTH: 42.0"	10 BOX



NuTrio TwistLok Silicone Feeding Tube
(For Use Up To 30 Days)

Orange-Striped Feeding Tube

Side Holes and End Hole

TwistLok Female Adapter with Non-Vented Plug

ENSI-40-50	5 French	PRIMING VOLUME: 0.30ml LENGTH (METRIC): 40.0cm LENGTH (INCHES): 15.7"	10 BOX
ENSI-60-50	5 French	PRIMING VOLUME: 0.50ml LENGTH (METRIC): 60.0cm LENGTH (INCHES): 23.6"	10 BOX
ENSI-90-50	5 French	PRIMING VOLUME: 0.60ml LENGTH (METRIC): 90.0cm LENGTH (INCHES): 35.4"	10 BOX
ENSI-40-65	6.5 French	PRIMING VOLUME: 0.50ml LENGTH (METRIC): 40.0cm LENGTH (INCHES): 15.7"	10 BOX
ENSI-60-65	6.5 French	PRIMING VOLUME: 0.60ml LENGTH (METRIC): 60.0cm LENGTH (INCHES): 23.6"	10 BOX
ENSI-90-65	6.5 French	PRIMING VOLUME: 0.90ml LENGTH (METRIC): 90.0cm LENGTH (INCHES): 35.4"	10 BOX
ENSI-40-80	8 French	PRIMING VOLUME: 0.70ml LENGTH (METRIC): 40.0cm LENGTH (INCHES): 15.7"	10 BOX
ENSI-60-80	8 French	PRIMING VOLUME: 1.00ml LENGTH (METRIC): 60.0cm LENGTH (INCHES): 23.6"	10 BOX
ENSI-90-80	8 French	PRIMING VOLUME: 1.50ml LENGTH (METRIC): 90.0cm LENGTH (INCHES): 35.4"	10 BOX

ELIMINATE
MISCONNECTIONS

NUTRIO ENTERAL FEEDING SYSTEM™

GRAVIFEED™: THE WORLD'S FIRST GRAVITY FEEDING SPECIFIC SYRINGE

Eliminate waste and save money while improving safety with the GraviFeed gravity feeding syringe.

- Built in TwistLok™ feature prevents accidental disengagement and dangerous misconnections between the feeding tube and GraviFeed syringe.
- Snap tight sealable lid prevents exposure to airborne particulates or contamination and the unnecessary loss of precious milk or formula.
- Reusable primer effortlessly creates positive pressure and eliminates the need for a plunger, which saves the hospital money.
- An easier way to deliver gravity feeding without the push and pull associated with a traditional plunger.
- Hydrophobic filter built into the lid allows air to pass through without letting enteral fluid leak out, making the GraviFeed a perfect solution for post feed venting.
- Non-DEHP, Latex Free.





Traditional
Venting

GraviFeed
Venting

Perfect for Venting – Venting with GraviFeed is as simple as snapping the lid closed. No gauze or hanging necessary.



Less Waste – GraviFeed utilizes a reusable primer to create positive pressure to initiate flow. This method eliminates waste because an expensive single use syringe plunger is not being thrown away with every feed. An optional single use plunger is available for hospitals not interested in switching to the reusable primer.

NuTrio: GraviFeed™

GF-30 NuTrio GraviFeed 30ml Syringe
Tethered Cap with 5 Micron
Hydrophobic Filter
TwistLok Non-Vented Cap

50
BOX

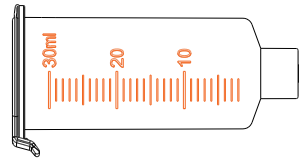

GF-60 NuTrio GraviFeed 60ml Syringe
Tethered Cap with 5 Micron
Hydrophobic Filter
TwistLok Non-Vented Cap

50
BOX

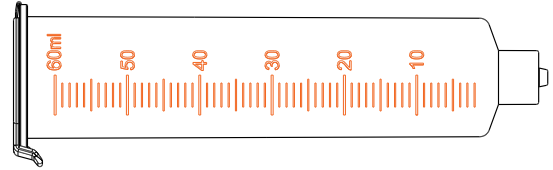

GF-001 NuTrio GraviFeed Plunger
(For Use With GF-30 and GF-60)

10
BOX

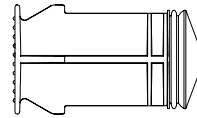

GF-002 NuTrio GraviFeed Primer

10
BOX

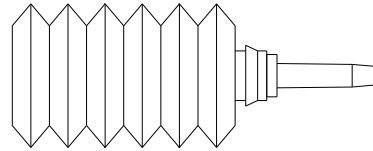

GF-002L Large NuTrio GraviFeed Primer

10
BOX

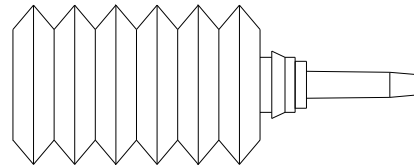

GF-003 GraviFeed Rack

1
EACH

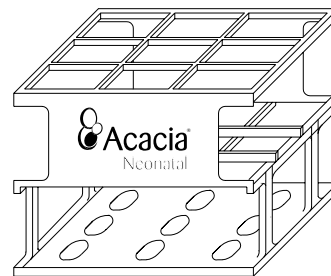

NuTrio: Intopo™ Enteral Syringes

INT-CAP NuTrio Intopo Non-Vented Cap, Orange

100
BOX

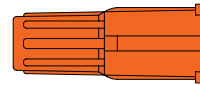

INT-01 NuTrio Intopo 1ml Syringe

100
BOX

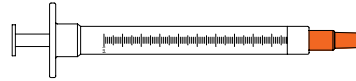

INT-03 NuTrio Intopo 3ml Syringe

100
BOX

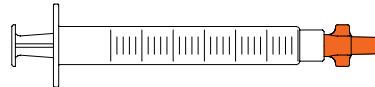

INT-05 NuTrio Intopo 5ml Syringe

100
BOX

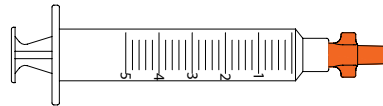

INT-10 NuTrio Intopo 10ml Syringe

100
BOX



INT-30 NuTrio Intopo 30ml Syringe

50
BOX

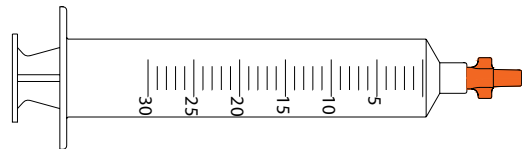

INT-60 NuTrio Intopo 60ml Syringe

50
BOX

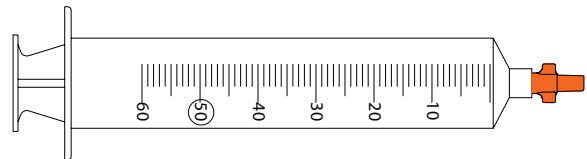

NuTrio: Intopo™ Extension Sets

EB-060-18 NuTrio Intopo Enteral Extension Set
 Orange-Striped Low-Volume Minibore Tubing
 Universal Enteral Connector
 Non-Removable Slide Clamp (White)
 TwistLok Female Adapter

PRIMING VOLUME:	1.3ml	100 BOX
LENGTH:	60.0"	

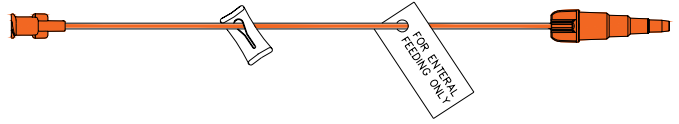

EB-060-182 NuTrio Intopo Enteral Extension Set
 Orange-Striped Minibore Tubing
 Universal Enteral Connector
 Non-Removable Slide Clamp (White)
 Oral Female Adapter

PRIMING VOLUME:	2.0ml	100 BOX
LENGTH:	60.0"	

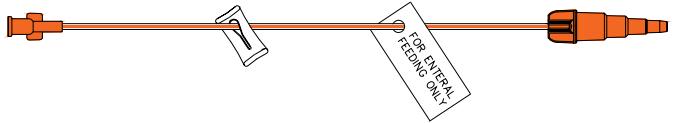

EB-060-19 NuTrio Intopo Enteral Extension Set
 Medication Port
 Orange-Striped Low-Volume Minibore Tubing
 Universal Enteral Connector
 Two Non-Removable Slide Clamps (White)
 Two TwistLok Female Adapters
 Non-Vented Plug

PRIMING VOLUME:	1.7ml	100 BOX
LENGTH:	60.0"	

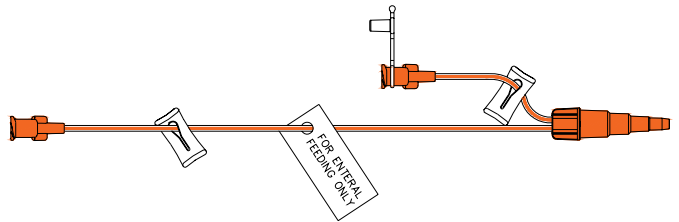

EB-060-192 NuTrio Intopo Enteral Extension Set
 Medication Port
 Orange-Striped Minibore Tubing
 Universal Enteral Connector
 Two Non-Removable Slide Clamps (White)
 Two Oral Female Adapters
 Non-Vented Plug

PRIMING VOLUME:	2.2ml	100 BOX
LENGTH:	60.0"	

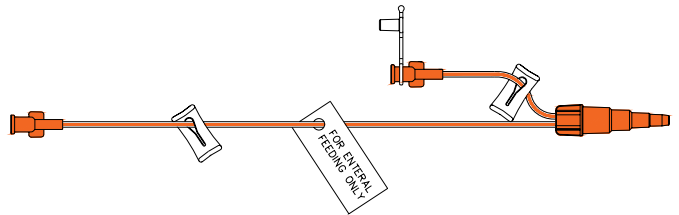

**REDUCE
INFECTION**

CLOSEDCARE™ I.V. SYSTEM



HR-012
Delivery: Medications
Flush: Bag

THE LEADER IN CLOSED MEDICATION DELIVERY FOR REDUCING INFECTION

Reducing infection is important in every area of the hospital, but even more so in the NICU where patients are extremely vulnerable. Factors such as touch contamination, excessive connection and disconnection due to commonly used flush techniques after medication infusion and using an open system for medication delivery can contribute to increases in infection rates.

Acacia Neonatal's ClosedCare™ I.V. System addresses these factors with a number of breakthrough design features.

CLOSEDCARE I.V. SYSTEM

PRODUCT FEATURES & BENEFITS:

- A number of the ClosedCare I.V. sets are designed to allow for multiple flushes from a 10ml prefilled flush syringe, decreasing touch contamination, thereby reducing the chance for infection.
- The ClosedCare I.V. System uses a pre-configured combination of needleless valves and stopcocks to create a closed system for medication, TPN and Lipid delivery.
- Hospital saves money with the reduction of flush syringes used, by up to 9 syringes per day.
- Needleless valves keep the sets closed, even after the medication syringe is disconnected.
- Brightly color-coded clamps may reduce the risk of mixing up infusion routes or solutions.
- MedSafe connector minimizes the exposure of incompatible medications.
- Non-DEHP, Latex Free.



Every ClosedCare I.V. set utilizes needleless valves to create a closed system to reduce infection for the delivery of medications.



The MedSafe feature, with its minimal dead space design, ensures that medication delivery is unaffected by TPN and Lipid lines.



Reduces the number of connections to set up I.V. lines to deliver TPN, Lipids and medications.

ClosedCare™ I.V. System

AG-089-01 ClosedCare™ I.V. System
 Trifurcated Set
 Low-Volume Minibore Tubing
 Anti-Siphon Valve
 Five Non-Removable Slide Clamps
 (Green, Blue, White)
 0.2 Micron Filter (24 hours)
 Four-Way Large Bore Stopcock
 Back Check Valve
 Vented Spike
 Three Female Luer Locks

PRIMING VOLUME:	4.8ml
LENGTH:	79"

25 BOX

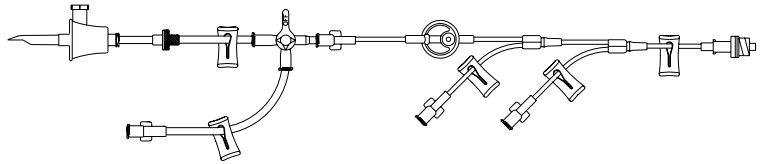

EA-062-01 ClosedCare™ I.V. System
 (BTO) Quadfurcated MedSafe Set
 Microbore Tubing
 Rotating Male Luer Lock
 Four Non-Removable Slide Clamps
 (Blue, Red, White, Yellow)
 Four-Way Large Bore Stopcock
 Non-Vented Cap, Back Check Valve
 0.2 Micron Filter (24 hours)
 Three Female Luer Locks

PRIMING VOLUME:	1.5ml
LENGTH:	62.0"

50 BOX

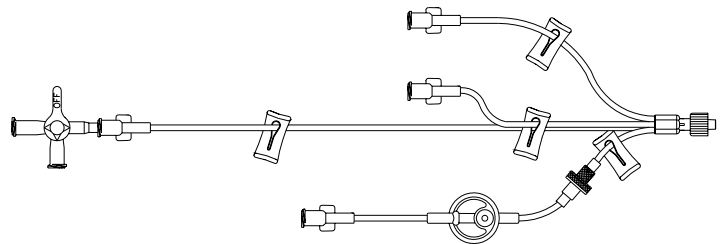

HR-004 ClosedCare™ I.V. System
 Trifurcated MedSafe Set
 Microbore Tubing
 Rotating Male Luer Lock
 Three Non-Removable Slide Clamps
 (Blue, White, Yellow)
 Four-Way Large Bore Stopcock
 HR Needleless Valve
 Non-Vented Cap
 0.2 Micron Filter (24 hours)
 Two Female Luer Locks

PRIMING VOLUME:	1.4ml
LENGTH:	62.0"

50 BOX

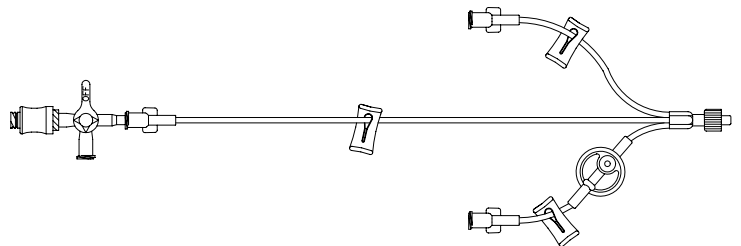

HR-006 ClosedCare™ I.V. System
 Trifurcated MedSafe Set
 Microbore Tubing
 Anti-Siphon Valve
 Three Non-Removable Slide Clamps
 (Blue, White, Yellow)
 Four-Way Large Bore Stopcock
 HR Needleless Valve
 0.2 Micron Filter (24 hours)
 Two Female Luer Locks
 Back Check Valve
 Pinch Clamp (White)
 Vented Spike

PRIMING VOLUME:	7.2ml
LENGTH:	64.0"

50 BOX

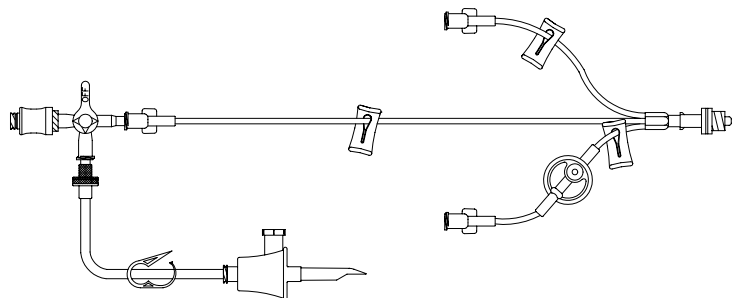

ClosedCare™ I.V. System

HR-008

ClosedCare™ I.V. System
 Microbore Tubing
 Rotating Male Luer Lock
 Non-Removable Slide Clamp (Blue)
 Four-Way Large Bore Stopcock
 Two HR Needleless Valves

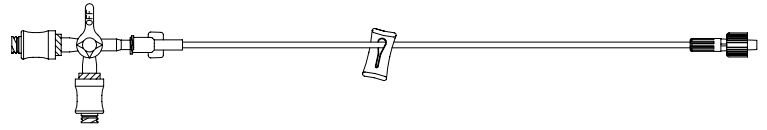

PRIMING VOLUME:	0.65ml	50 BOX
LENGTH:	62.0"	

HR-012

ClosedCare™ I.V. System
 Microbore Tubing
 Anti-Siphon Valve
 Non-Removable Slide Clamp (Blue)
 T-connector
 HR Needleless Valve
 Back Check Valve
 Pinch Clamp (White)
 Vented Spike

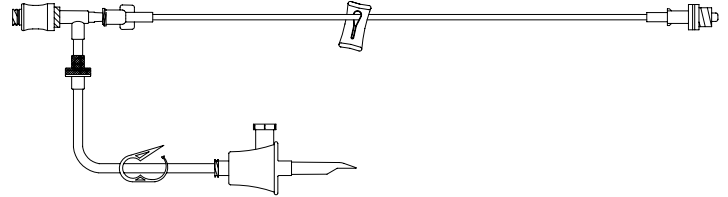

PRIMING VOLUME:	6.3ml	50 BOX
LENGTH:	61.75"	

SM-039

ClosedCare™ I.V. System
 Minibore Tubing
 Anti-Siphon Valve
 Four-Way Large Bore Stopcock
 Female Luer Lock
 SmartSite Needleless Valve
 Back Check Valve
 Pinch Clamp (White)
 Vented Spike

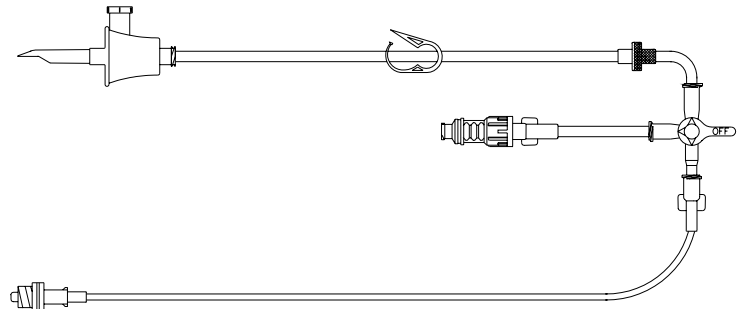

PRIMING VOLUME:	8.7ml	50 BOX
LENGTH:	20.5"	

MEDSAFE AND MULTI-ACCESS SETS



BG-004-03
MedSafe Quadfurcated
Extension Set

IMPROVE MEDICATION SAFETY AT THE POINT OF CARE

Acacia Neonatal's MedSafe and Multi-Access Sets are designed specifically to meet the challenges of drug delivery in neonates. With a limited number of viable vascular access points, a multi-route set is essential. Too often, the need arises to create multi-access sets by building awkward and heavy piecemeal sets at the bedside. This practice increases the chance of infection through touch contamination as well as adding to

variability in line set-up, which increases risk of error. Also, the additional tubing length of multiple sets makes delivery of the drug inaccurate and may increase incompatibility issues.

MedSafe and Multi-Access Sets are pre-assembled and patient ready. The MedSafe's unique feature minimizes drug interaction to decrease the chance of dangerous medication errors.

PRODUCT FEATURES & BENEFITS:

- **Minimal Dead Space** – The MedSafe connector minimizes potential drug incompatibility in the fluid path, with the shortest common fluid juncture available today.
- **Proper Drug Delivery For Neonates** – MedSafe and Multi-Access Sets are designed for multiple small volume medication delivery, and minimize the risk for incompatibility problems and pooling of medication in the line while minimizing the need for additional flush volume. These features ensure the patient is receiving the medication as administered.
- **Reduced Chance of Infections** – These sets are pre-assembled and patient ready, minimizing the need for additional sets, thereby reducing the risk of infection by touch contamination.
- **Low Priming Volumes** – MedSafe and Multi-Access Sets have very low priming volumes and short lengths.
- **Lightweight** – The specially designed connector is nearly weightless with an easy rotating luer lock to reduce the chance for kinking and pulling.
- **Color Coded** – Slide clamps are different colors for easy, at a glance, line identification.
- **Cost Effective** – Purchasing pre-assembled MedSafe and Multi-Access Sets reduce the need to stock several individual sets leading to a possible decrease in costs.
- **Non-DEHP, Latex Free.**



The MedSafe connector minimizes the sets' dead space.



The sets are pre-assembled and patient ready in Bi-, Tri- (pictured) and quadfurcated configurations.



Each set features color coded slide clamps for ease of use.

MedSafe and Multi-Access Sets

BB-004-01 MedSafe Multi-Access Set
 Bifurcated
 Minibore Tubing
 Rotating Male Luer Lock
 Two Non-Removable Slide Clamps (White)
 Back Check Valve
 Female Luer Lock

PRIMING VOLUME:	0.4ml	50 BOX
LENGTH:	4.0"	

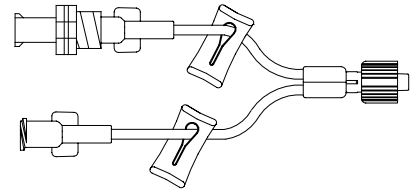

BB-004-02 Multi-Access Set
 (BTO)
 Trifurcated
 Minibore Tubing
 Rotating Male Luer Lock
 Two Non-Removable Slide Clamps (White)
 Two Back Check Valves
 Female Luer Lock

PRIMING VOLUME:	1ml	50 BOX
LENGTH:	6.0"	

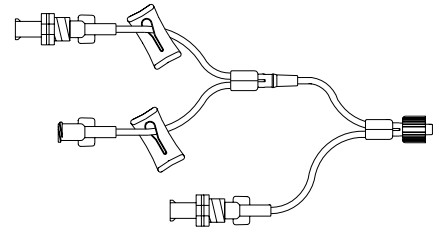

BB-004-03 MedSafe Multi-Access Set
 Bifurcated
 Minibore Tubing
 Rotating Male Luer Lock
 Two Non-Removable Slide Clamps (White, Blue)
 Two Female Luer Locks
 Two Non-Vented Caps

PRIMING VOLUME:	0.4ml	50 BOX
LENGTH:	4.0"	

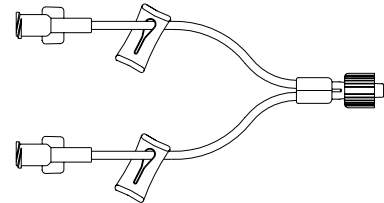

BB-004-04 MedSafe Multi-Access Set
 Bifurcated
 Minibore Tubing
 Rotating Male Luer Lock
 Two Non-Removable Slide Clamps (White, Blue)
 Two Split-Septum Injection Sites

PRIMING VOLUME:	0.6ml	50 BOX
LENGTH:	6.0"	

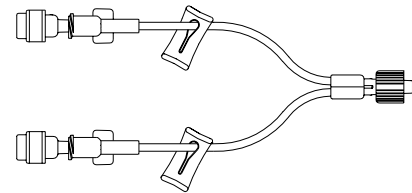

BB-005-01 MedSafe Multi-Access Set
 (BTO)
 Bifurcated
 Minibore Tubing
 Rotating Male Luer Lock
 Two Non-Removable Slide Clamps (White, Blue)
 Two HR Needleless Valves

PRIMING VOLUME:	0.6ml	50 BOX
LENGTH:	5.0"	

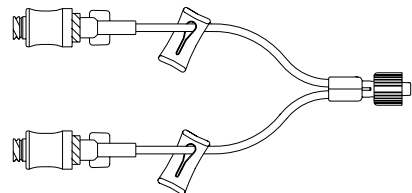

MedSafe and Multi-Access Sets

BC-006-03 Multi-Access Set
 Bifurcated
 Small Kink Resistant Tubing
 Rotating Male Luer Lock
 Three Pinch Clamps (White, Blue)
 Two Female Luer Locks
 Two Non-Vented Caps

PRIMING VOLUME:	0.70ml	50 BOX
LENGTH:	7.0"	

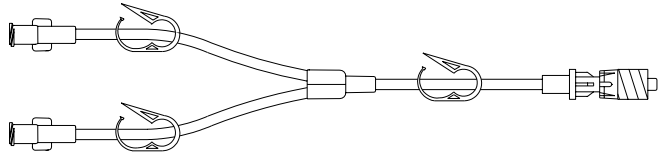

BE-006-01 Multi-Access Set
 Trifurcated
 Large Kink Resistant Tubing
 Rotating Male Luer Lock
 Four Pinch Clamps (White, Red, Blue)
 Three Female Luer Locks
 Three Non-Vented Caps

PRIMING VOLUME:	1.4ml	50 BOX
LENGTH:	7.0"	

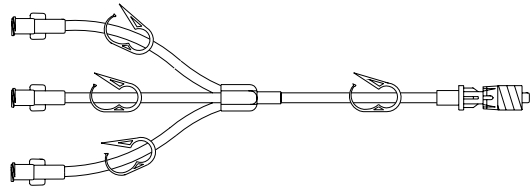

BG-004-02 MedSafe Multi-Access Set
 Trifurcated
 Low-Volume Minibore Tubing
 Rotating Male Luer Lock
 Three Non-Removable Slide Clamps
 (White, Yellow, Blue)
 Three Female Luer Locks

PRIMING VOLUME:	0.4ml	50 BOX
LENGTH:	4.0"	

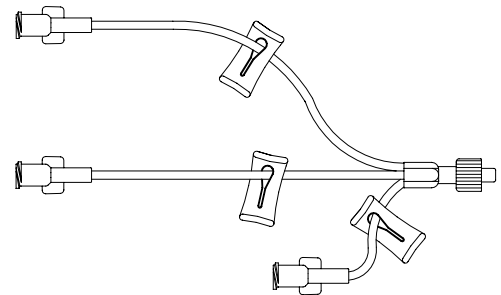

BG-004-03 MedSafe Multi-Access Set
 Quadfurcated
 Low-Volume Minibore Tubing
 Rotating Male Luer Lock
 Four Non-Removable Slide Clamps
 (White, Yellow, Green, Blue)
 Four Female Luer Locks

PRIMING VOLUME:	0.5ml	50 BOX
LENGTH:	4.0"	

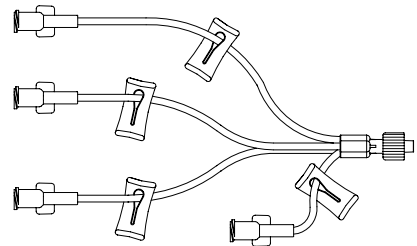

BG-004-05 MedSafe Multi-Access Set
 Trifurcated
 Low-Volume Minibore Tubing
 Rotating Male Luer Lock
 Three Non-Removable Slide Clamps
 (Red, White, Yellow)
 Female Luer Lock
 Two Back Check Valves

PRIMING VOLUME:	0.55ml	50 BOX
LENGTH:	4.0"	

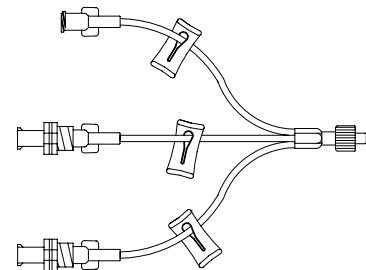

MedSafe and Multi-Access Sets

BG-004-07
(BTO)

Multi-Access Set
Trifurcated
Low-Volume Minibore Tubing
Rotating Male Luer Lock
Three Non-Removable Slide Clamps
(White, Yellow, Blue)
Three Female Luer Locks

PRIMING VOLUME:	0.5ml
LENGTH:	6.5"

50
BOX

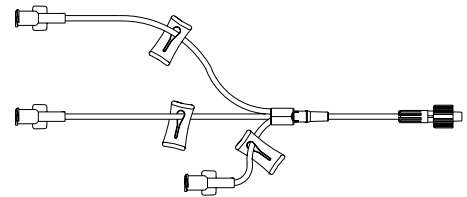

BG-004-08
(BTO)

MedSafe Multi-Access Set
Trifurcated
Low-Volume Minibore Tubing
Fixed Male Luer Lock
Three Non-Removable Slide Clamps
(Blue, White, Green)
Three Back Check Valves

PRIMING VOLUME:	0.8ml
LENGTH:	3.5"

50
BOX

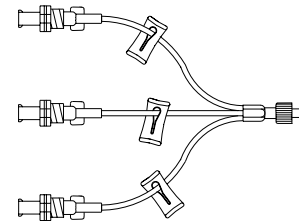

BG-005-01

MedSafe Multi-Access Set
Quadfurcated
Low-Volume Minibore Tubing
Four Non-Removable Slide Clamps
(White, Yellow, Green, Blue)
Three Back Check Valves
Female Luer Lock

PRIMING VOLUME:	0.65ml
LENGTH:	5.0"

50
BOX

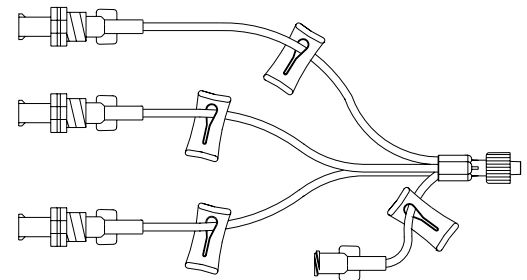

BG-005-02

MedSafe Multi-Access Set
Trifurcated
Low-Volume Minibore Tubing
Rotating Male Luer Lock
Three Non-Removable Slide Clamps
(White, Yellow, Blue)
Female Luer Lock
Two Back Check Valves

PRIMING VOLUME:	0.5ml
LENGTH:	5"

50
BOX

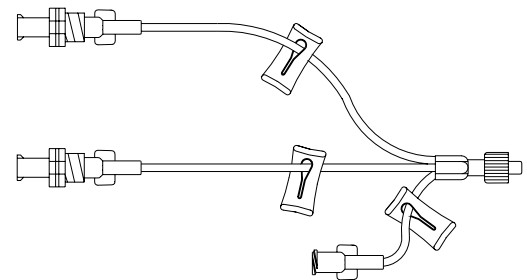

BG-005-05
(BTO)

MedSafe Multi-Access Set
Quadfurcated
Low-Volume Minibore Tubing
Rotating Male Luer Lock
Four Non-Removable Slide Clamps
(White, Blue, Green, Yellow)
Female Luer Lock, Three Back Check Valves

PRIMING VOLUME:	0.65ml
LENGTH:	5.0"

50
BOX

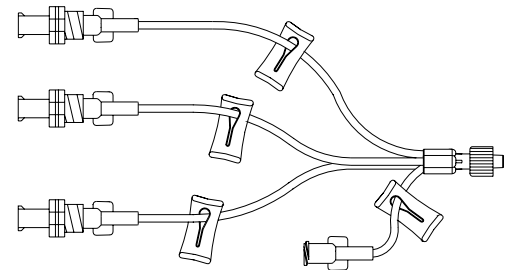

MedSafe and Multi-Access Sets

BG-005-06 MedSafe Multi-Access Set
 Trifurcated
 Low-Volume Minibore Tubing
 Rotating Male Luer Lock
 Three Non-Removable Slide Clamps
 (White, Blue, Yellow)
 Female Luer Lock
 Two Back Check Valves

PRIMING VOLUME:	0.5ml	50 BOX
LENGTH:	5.0"	

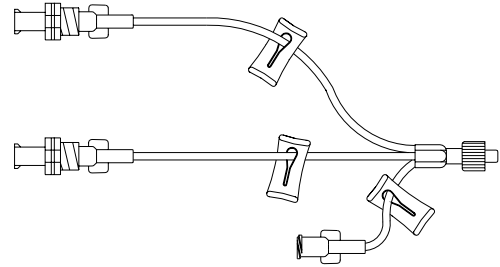

BG-006-01 Multi-Access Set
 Trifurcated
 Low-Volume Minibore Tubing
 Rotating Male Luer Lock
 Four Removable Slide Clamps (White)
 Three Female Luer Locks
 Three Non-Vented Caps

PRIMING VOLUME:	0.5ml	50 BOX
LENGTH:	7.0"	

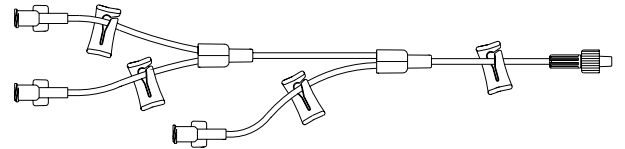

BG-006-02 Multi-Access Set
 Quadfurcated
 Low-Volume Minibore Tubing
 Rotating Male Luer Lock
 Five Removable Slide Clamps (White)
 Four Female Luer Locks
 Four Non-Vented Caps

PRIMING VOLUME:	0.5ml	50 BOX
LENGTH:	7.0"	

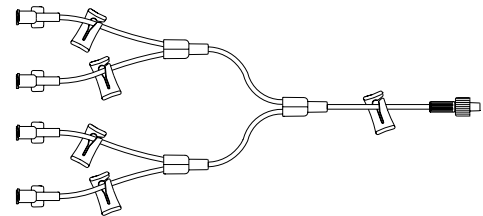

BG-007-01 Multi-Access Set
 Bifurcated
 Low-Volume Minibore Tubing
 Rotating Male Luer Lock
 Three Removable Slide Clamps (White)
 0.2 Micron Filter (24 Hours)
 Two Female Luer Locks
 Two Non-Vented Caps

PRIMING VOLUME:	0.6ml	50 BOX
LENGTH:	6.0"	

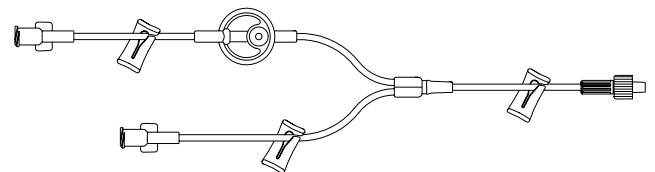

BG-007-03 Multi-Access Set
 Trifurcated
 Low-Volume Minibore Tubing
 Fixed Male Luer Lock
 Four Non-Removable Slide Clamps
 (Green, Yellow, White, Blue)
 0.2 Micron Filter (24 Hours)
 Three Female Luer Locks
 Three Non-Vented Caps

PRIMING VOLUME:	0.85ml	50 BOX
LENGTH:	16.0"	

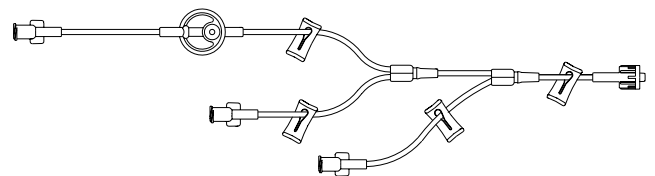

MedSafe and Multi-Access Sets

BG-007-04	<p>Multi-Access Set Bifurcated Low-Volume Minibore Tubing Fixed Male Luer Lock Three Removable Slide Clamps (White) 0.2 Micron Filter (24 Hours) Two Female Luer Locks Two Non-Vented Caps</p>						
	<table border="1" style="border-collapse: collapse;"> <tr> <td style="padding: 2px;">PRIMING VOLUME:</td> <td style="padding: 2px;">0.6ml</td> </tr> <tr> <td style="padding: 2px;">LENGTH:</td> <td style="padding: 2px;">6.0"</td> </tr> </table>	PRIMING VOLUME:	0.6ml	LENGTH:	6.0"	<table border="1" style="border-collapse: collapse;"> <tr> <td style="padding: 2px;">50 BOX</td> </tr> </table>	50 BOX
PRIMING VOLUME:	0.6ml						
LENGTH:	6.0"						
50 BOX							

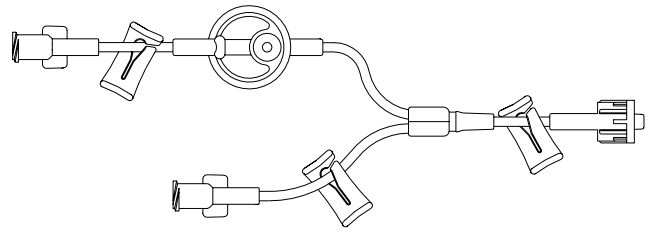

BG-008-01	<p>MedSafe Multi-Access Set Bifurcated Minibore Tubing Rotating Male Luer Lock 0.2 Micron Filter (24 Hours) Two Non-Removable Slide Clamps (White, Yellow) Two Female Luer Locks</p>						
	<table border="1" style="border-collapse: collapse;"> <tr> <td style="padding: 2px;">PRIMING VOLUME:</td> <td style="padding: 2px;">0.8ml</td> </tr> <tr> <td style="padding: 2px;">LENGTH:</td> <td style="padding: 2px;">8.0"</td> </tr> </table>	PRIMING VOLUME:	0.8ml	LENGTH:	8.0"	<table border="1" style="border-collapse: collapse;"> <tr> <td style="padding: 2px;">50 BOX</td> </tr> </table>	50 BOX
PRIMING VOLUME:	0.8ml						
LENGTH:	8.0"						
50 BOX							

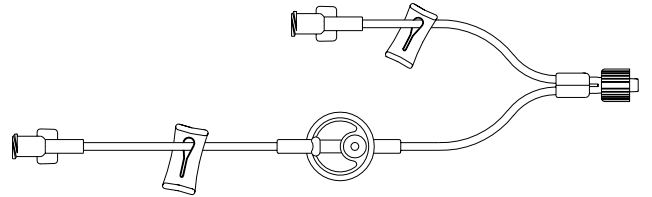

DB-003-03	<p>MedSafe Multi-Access Set Bifurcated Minibore Tubing Rotating Male Luer Lock Two Back Check Valves</p>						
	<table border="1" style="border-collapse: collapse;"> <tr> <td style="padding: 2px;">PRIMING VOLUME:</td> <td style="padding: 2px;">0.4ml</td> </tr> <tr> <td style="padding: 2px;">LENGTH:</td> <td style="padding: 2px;">2.5"</td> </tr> </table>	PRIMING VOLUME:	0.4ml	LENGTH:	2.5"	<table border="1" style="border-collapse: collapse;"> <tr> <td style="padding: 2px;">50 BOX</td> </tr> </table>	50 BOX
PRIMING VOLUME:	0.4ml						
LENGTH:	2.5"						
50 BOX							

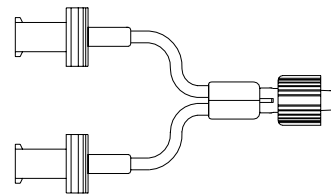

DB-004-01	<p>Multi-Access Set Quadfurcated Minibore Tubing Male Luer Slip Two Double T-Connectors Four Removable Slide Clamps (White) Four Female Luer Locks Five Non-Vented Caps</p>						
	<table border="1" style="border-collapse: collapse;"> <tr> <td style="padding: 2px;">PRIMING VOLUME:</td> <td style="padding: 2px;">1.1ml</td> </tr> <tr> <td style="padding: 2px;">LENGTH:</td> <td style="padding: 2px;">3.5"</td> </tr> </table>	PRIMING VOLUME:	1.1ml	LENGTH:	3.5"	<table border="1" style="border-collapse: collapse;"> <tr> <td style="padding: 2px;">50 BOX</td> </tr> </table>	50 BOX
PRIMING VOLUME:	1.1ml						
LENGTH:	3.5"						
50 BOX							

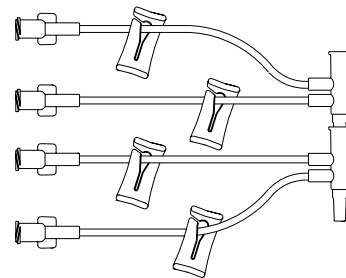

DB-006-13	<p>Multi-Access Set Bifurcated Minibore Tubing Rotating Male Luer Lock Double T-Injection Site Two Removable Slide Clamps (White) Two Female Luer Locks Two Non-Vented Caps</p>						
	<table border="1" style="border-collapse: collapse;"> <tr> <td style="padding: 2px;">PRIMING VOLUME:</td> <td style="padding: 2px;">0.5ml</td> </tr> <tr> <td style="padding: 2px;">LENGTH:</td> <td style="padding: 2px;">4.0"</td> </tr> </table>	PRIMING VOLUME:	0.5ml	LENGTH:	4.0"	<table border="1" style="border-collapse: collapse;"> <tr> <td style="padding: 2px;">50 BOX</td> </tr> </table>	50 BOX
PRIMING VOLUME:	0.5ml						
LENGTH:	4.0"						
50 BOX							

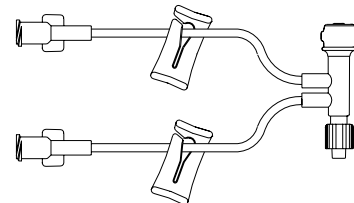

MedSafe and Multi-Access Sets

DG-010-01
(BTO)

MedSafe Multi-Access Set
Trifurcated
Low-Volume Minibore tubing
Rotating Male Luer Lock
Three Non-Removable Slide Clamps (White)
0.2 Micron Filter (96 Hours)
Three Female Luer Locks
Two Non-Vented Caps

PRIMING VOLUME:	3.6ml
LENGTH:	10.0"

50
BOX

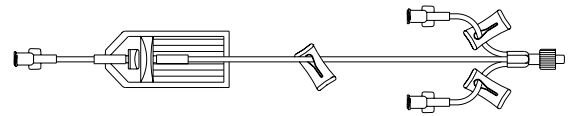

EA-086-01
(BTO)

MedSafe Multi-Access Set
Bifurcated
Green-Striped Microbore Tubing
Rotating Male Luer Lock
Two Non-Removable Slide Clamps (White)
Two Back Check Valves

PRIMING VOLUME:	1.0ml
LENGTH:	86.0"

50
BOX

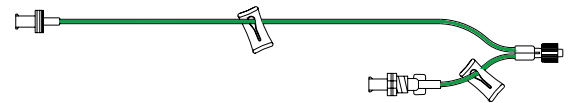

EG-016-01

MedSafe Multi-Access Set
Trifurcated
Low-Volume Minibore Tubing
Rotating Male Luer Lock
Three Non-Removable Slide Clamps
(Yellow, White, Blue)
0.2 Micron Filter (24 Hours)
Three Female Luer Locks
Two Non-Vented Caps

PRIMING VOLUME:	0.9ml
LENGTH:	16.0"

50
BOX

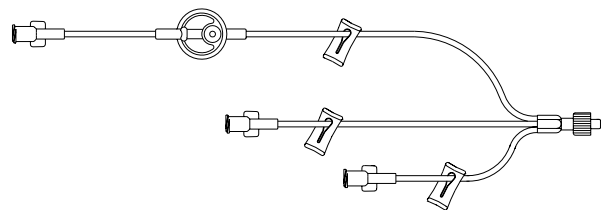

EG-016-02

MedSafe Multi-Access Set
Trifurcated
Low-Volume Minibore Tubing
Rotating Male Luer Lock
Three Back Check Valves
Three Non-Removable Slide Clamps
(Yellow, White, Blue)
0.2 Micron Filter (24 Hours)
Female Luer Lock

PRIMING VOLUME:	1.0ml
LENGTH:	16.0"

50
BOX

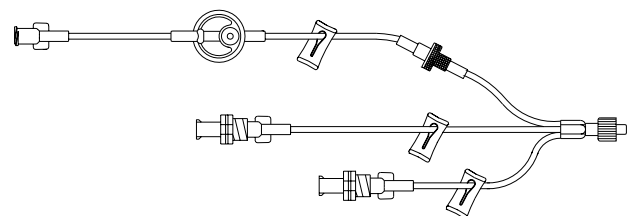

RC-004

MedSafe Multi-Access Set
Quadfurcated
Low-Volume Minibore Tubing
Fixed Male Luer Lock
Four Non-Removable Slide Clamps
(Green, Red, Yellow, White)
Three Back Check Valves
Female Luer Lock

PRIMING VOLUME:	0.8ml
LENGTH:	4.0"

50
BOX

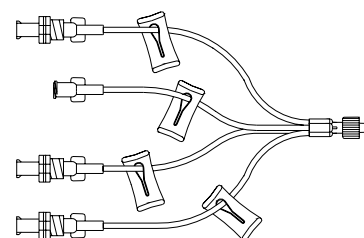

MedSafe and Multi-Access Sets

SM-037

MedSafe Multi-Access Set
 Trifurcated
 Minibore Tubing
 Three Non-Removable Slide Clamps
 (White, Yellow, Blue)
 Three SmartSite Needleless Valves

PRIMING VOLUME:	0.8ml	50 BOX
LENGTH:	5.0"	

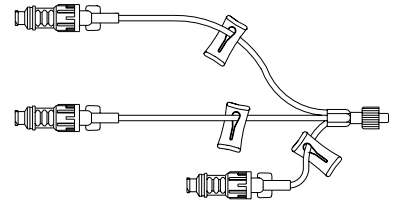

SM-055

MedSafe Multi-Access Set
 Trifurcated
 Microbore Tubing
 Rotating Male Luer Lock
 Three Non-Removable Slide Clamps
 (Blue, White, Yellow)
 Four-Way Large Bore Stopcock
 Two SmartSite Needleless Valves
 Two Back Check Valves
 Fixed Male Luer Lock
 0.2 Micron Filter (24 Hours)
 Female Luer Lock

PRIMING VOLUME:	1.75ml	50 BOX
LENGTH:	62.0"	

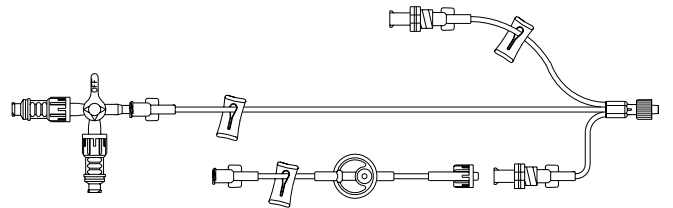

NICU Specialty I.V. Sets

EA-036-01 NICU Specialty I.V. Set
 Microbore Tubing
 Fixed Male Luer Lock
 Removable Slide Clamp (White)
 Female Luer Lock

PRIMING VOLUME:	0.20ml	50 BOX
LENGTH:	36.0"	

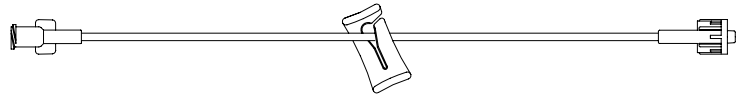

EA-060-01 NICU Specialty I.V. Set
 Microbore Tubing
 Fixed Male Luer Lock
 Removable Slide Clamp (Blue)
 Female Luer Lock

PRIMING VOLUME:	0.30ml	50 BOX
LENGTH:	60.0"	

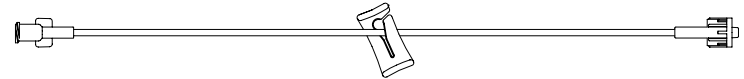

EA-060-05 (BTO) NICU Specialty I.V. Set
 Microbore Tubing
 Fixed Male Luer Lock
 0.2 Micron Filter (24 hours)
 Removable Slide Clamp (White)
 Female Luer Lock

PRIMING VOLUME:	0.60ml	50 BOX
LENGTH:	60.0"	



EB-004-12 NICU Specialty I.V. Set
 Minibore Tubing
 Male Luer Slip
 T-injection Site
 Non-Removable Slide Clamp (White)
 Female Luer Lock
 Non-Vented Cap

PRIMING VOLUME:	0.25ml	100 BOX
LENGTH:	4.0"	

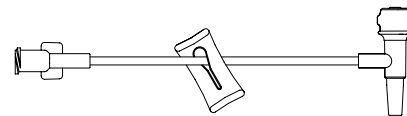

EB-006-11 NICU Specialty I.V. Set
 Minibore Tubing
 Male Luer Slip
 T-injection Site
 Removable Slide Clamp (White)
 Female Luer Lock
 Non-Vented Cap

PRIMING VOLUME:	0.30ml	50 BOX
LENGTH:	6.0"	

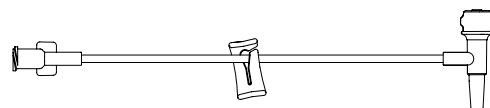

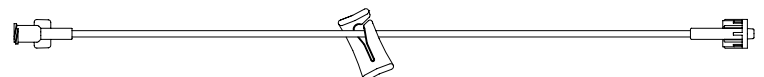

EB-030-02 NICU Specialty I.V. Set
 Minibore Tubing
 Fixed Male Luer Lock
 Removable Slide Clamp (White)
 Female Luer Lock

PRIMING VOLUME:	1.0ml	50 BOX
LENGTH:	30.0"	

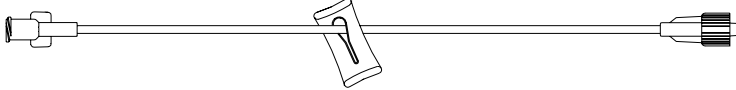

NICU Specialty I.V. Sets

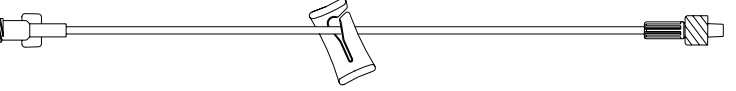
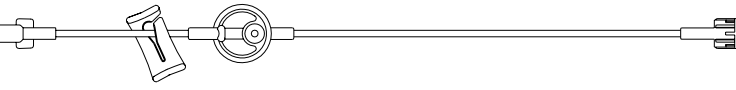
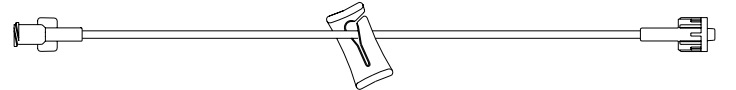
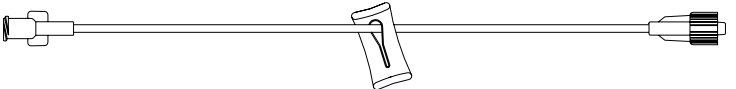
EB-036-02	NICU Specialty I.V. Set Minibore Tubing Fixed Male Luer Lock Non-Removable Slide Clamp (Blue) Female Luer Lock						
<table border="1"> <tr> <td>PRIMING VOLUME:</td> <td>1.10ml</td> <td rowspan="2" style="text-align: center; vertical-align: middle;">50 BOX</td> </tr> <tr> <td>LENGTH:</td> <td>36.0"</td> </tr> </table>		PRIMING VOLUME:	1.10ml	50 BOX	LENGTH:	36.0"	
PRIMING VOLUME:	1.10ml	50 BOX					
LENGTH:	36.0"						
EB-060-01	NICU Specialty I.V. Set Minibore Tubing Fixed Male Luer Lock Pinch Clamp (White) Female Luer Lock						
<table border="1"> <tr> <td>PRIMING VOLUME:</td> <td>2.00ml</td> <td rowspan="2" style="text-align: center; vertical-align: middle;">50 BOX</td> </tr> <tr> <td>LENGTH:</td> <td>60.0"</td> </tr> </table>		PRIMING VOLUME:	2.00ml	50 BOX	LENGTH:	60.0"	
PRIMING VOLUME:	2.00ml	50 BOX					
LENGTH:	60.0"						
EB-060-03	NICU Specialty I.V. Set Minibore Tubing Rotating Male Luer Lock Removable Slide Clamp (White) Female Luer Lock						
<table border="1"> <tr> <td>PRIMING VOLUME:</td> <td>2.00ml</td> <td rowspan="2" style="text-align: center; vertical-align: middle;">50 BOX</td> </tr> <tr> <td>LENGTH:</td> <td>60.0"</td> </tr> </table>		PRIMING VOLUME:	2.00ml	50 BOX	LENGTH:	60.0"	
PRIMING VOLUME:	2.00ml	50 BOX					
LENGTH:	60.0"						
EB-060-04	NICU Specialty I.V. Set Minibore Tubing Fixed Male Luer Lock 0.2 Micron Filter (24 hours) Removable Slide Clamp (White) Female Luer Lock						
<table border="1"> <tr> <td>PRIMING VOLUME:</td> <td>2.00ml</td> <td rowspan="2" style="text-align: center; vertical-align: middle;">50 BOX</td> </tr> <tr> <td>LENGTH:</td> <td>60.0"</td> </tr> </table>		PRIMING VOLUME:	2.00ml	50 BOX	LENGTH:	60.0"	
PRIMING VOLUME:	2.00ml	50 BOX					
LENGTH:	60.0"						
EG-060-01	NICU Specialty I.V. Set Low-Volume Minibore Tubing Fixed Male Luer Lock Removable Slide Clamp (White) Female Luer Lock						
<table border="1"> <tr> <td>PRIMING VOLUME:</td> <td>1.00ml</td> <td rowspan="2" style="text-align: center; vertical-align: middle;">50 BOX</td> </tr> <tr> <td>LENGTH:</td> <td>60.0"</td> </tr> </table>		PRIMING VOLUME:	1.00ml	50 BOX	LENGTH:	60.0"	
PRIMING VOLUME:	1.00ml	50 BOX					
LENGTH:	60.0"						
EI-060-02	NICU Specialty I.V. Set Large Microbore Tubing Fixed Male Luer Lock Non-Removable Slide Clamp (White) Female Luer Lock						
<table border="1"> <tr> <td>PRIMING VOLUME:</td> <td>0.60ml</td> <td rowspan="2" style="text-align: center; vertical-align: middle;">50 BOX</td> </tr> <tr> <td>LENGTH:</td> <td>60.0"</td> </tr> </table>		PRIMING VOLUME:	0.60ml	50 BOX	LENGTH:	60.0"	
PRIMING VOLUME:	0.60ml	50 BOX					
LENGTH:	60.0"						

NICU Specialty I.V. Sets

EI-060-04

NICU Specialty I.V. Set
Large Microbore Tubing
Anti-Siphon Valve
Non-Removable Slide Clamp (White)
Female Luer Lock

PRIMING VOLUME:	0.70ml	50 BOX
LENGTH:	61.0"	

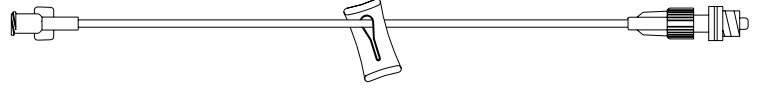

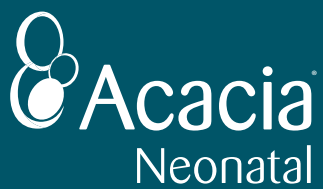

Distributed By:



11733 66th St N Suite 113
Largo, FL 33773

PH: 888.548.4462
FX: 888.548.1462

E-Mail: info@I-MA.com
Web: www.I-MA.com